



ELIA

Pedestal

REF: 18430

Pedestal for Elia wash-basin, with soft and rounded shapes.

Wash-basin and tap fittings not included.
Available while stocks last.

REF. 18430

COLORES / ACABADOS

01
Blanco

SUGERENCIAS



ARTÍCULOS

Ref.	Producto/Conjunto	Medidas	€/u
18430	Pedestal		46,1 €
Opciones			
18030	Lavabo con juego de fijación	65 x 51 cm	70,0 €
18040	Lavabo con juego de fijación	60 x 48,5 cm	66,0 €
18050	Lavabo con juego de fijación	55 x 45,5 cm	65,0 €

INFORMACIÓN DE PRODUCTO

Características

Pedestal. / 9 kg. / 40 units pallet.

Garantía

Gala products are guaranteed against any manufacturing defects, from the date of purchase of the product, only if the installation has been carried out in accordance with Gala's installation instructions and, applying the current legislation on electrical and sanitary appliances, by authorised staff. The guarantee period for vitreous china is of 5 years.

Instalación

Please check our product installation manuals.

Certificaciones

High quality is a constant at Gala in order to guarantee the technical and aesthetic features as well as the performance of our products. Please check our product quality certificates.

Mantenimiento

Cleaning should preferably be carried out using liquid detergent and a brush or sponge. Do not scrape with metal blades or steel scourer.

AMBIENTE





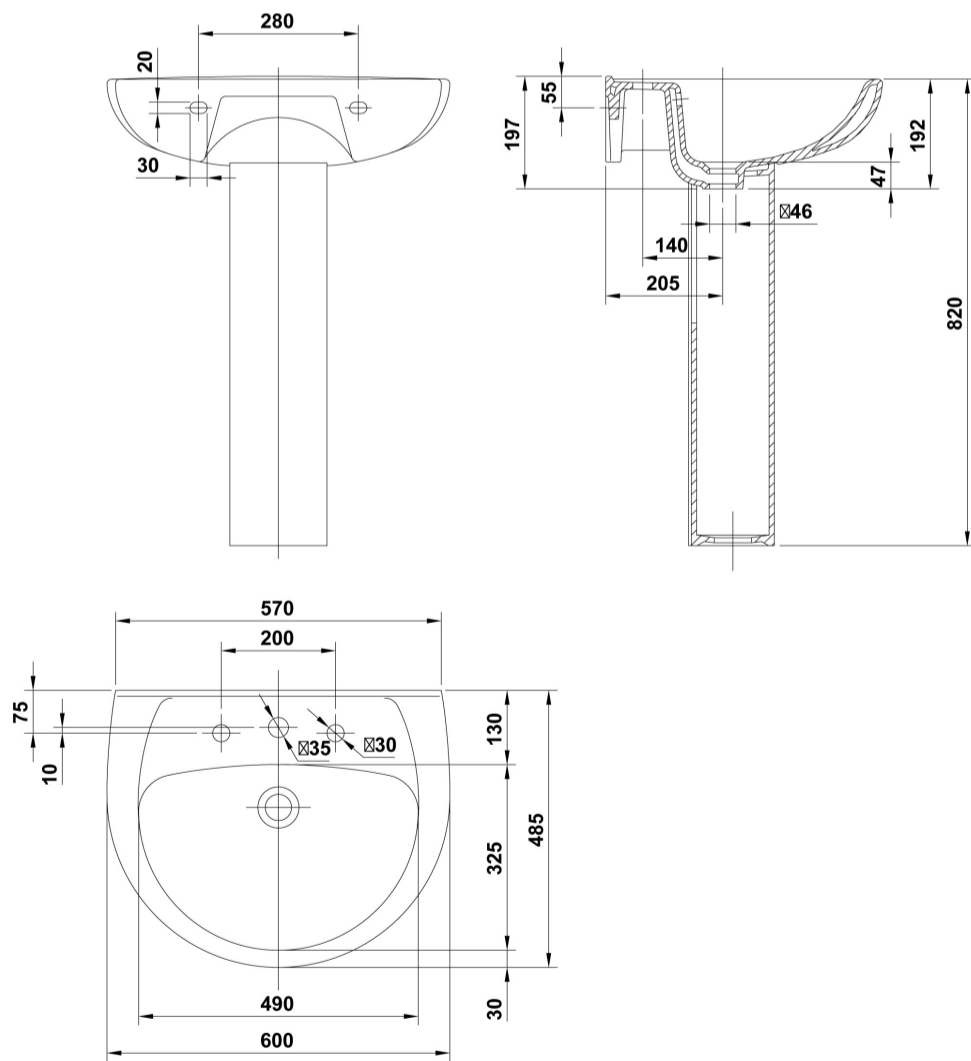

















DIBUJOS TÉCNICOS



DESCARGAS

2D

-  82.1 KB  Pedestal - Técnico (.AI)
-  100.33 KB  Pedestal - Técnico (.DWG)
-  723.47 KB  Pedestal - Técnico (.DXF)
-  95.55 KB  Pedestal - Técnico (.PDF)
-  24.89 KB  Pedestal - Alzado (.DWG)
-  18.78 KB  Pedestal - Alzado (.DXF)
-  25.07 KB  Pedestal - Lateral (.DWG)
-  19.49 KB  Pedestal - Lateral (.DXF)
-  28.48 KB  Pedestal - Planta (.DWG)
-  20.15 KB  Pedestal - Planta (.DXF)

3D

-  1.64 MB  Pedestal - 3D (.DWG)
-  4.15 MB  Pedestal - 3D (.DXF)

bimobject

-  ArchiCAD 
-  Revit 